

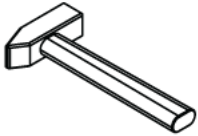

	art.: 11640102	XEM: Wardrobe 2d	18-04-2023
BG ИНСТРУКЦИИ ЗА СГЛОБЯВАНЕ	ET KOKKUVÕTMISJUHISED	IT ISTRUZIONI DI MONTAGGIO	PL INSTRUKCJE SKŁADANIA
CS MONTÁŽNÍ NÁVOD	FI KOKOAMISOHJEET	LT SURINKIMO INSTRUKCIJA	PT INSTRUÇÕES DE MONTAGEM
DA MONTERINGSINSTRUKTIONER	FR NOTICE DE MONTAGE	LV MONTĀŽAS NORĀDĪJUMI	RO INSTRUȚIUNI DE ASAMBLARE
DE MONTAGEANLEITUNGEN	GA IONSTRAIMÍ TIONÓL	MK/SL УПАТСТВО ЗА СОБРАЊИЕ	SK MONTÁŽNE POKYNY
EL ΟΔΗΓΙΕΣ ΣΥΝΑΡΜΟΛΟΓΗΣΗΣ	HR UPUTE ZA MONTAŽU	MT STRUZZJONIJIET TA 'ASSEMBLEA	SL NAVODILA ZA MONTAŽO
EN ASSEMBLY INSTRUCTIONS	HU ÖSSZESZERELÉSI ÚTMUTATÓ	NL MONTAGE HANDLEIDING	SR УПУТСТВО ЗА МОНТИРАЊЕ
ES INSTRUCCIONES DE MONTAJE	IS LEIÐBEININGAR	NO MONTERINGSINSTRUKSJONER	TR MONTAJ TALİMATLARI

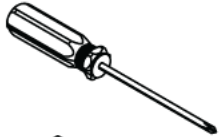

90 min.

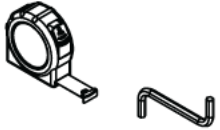
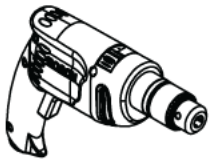
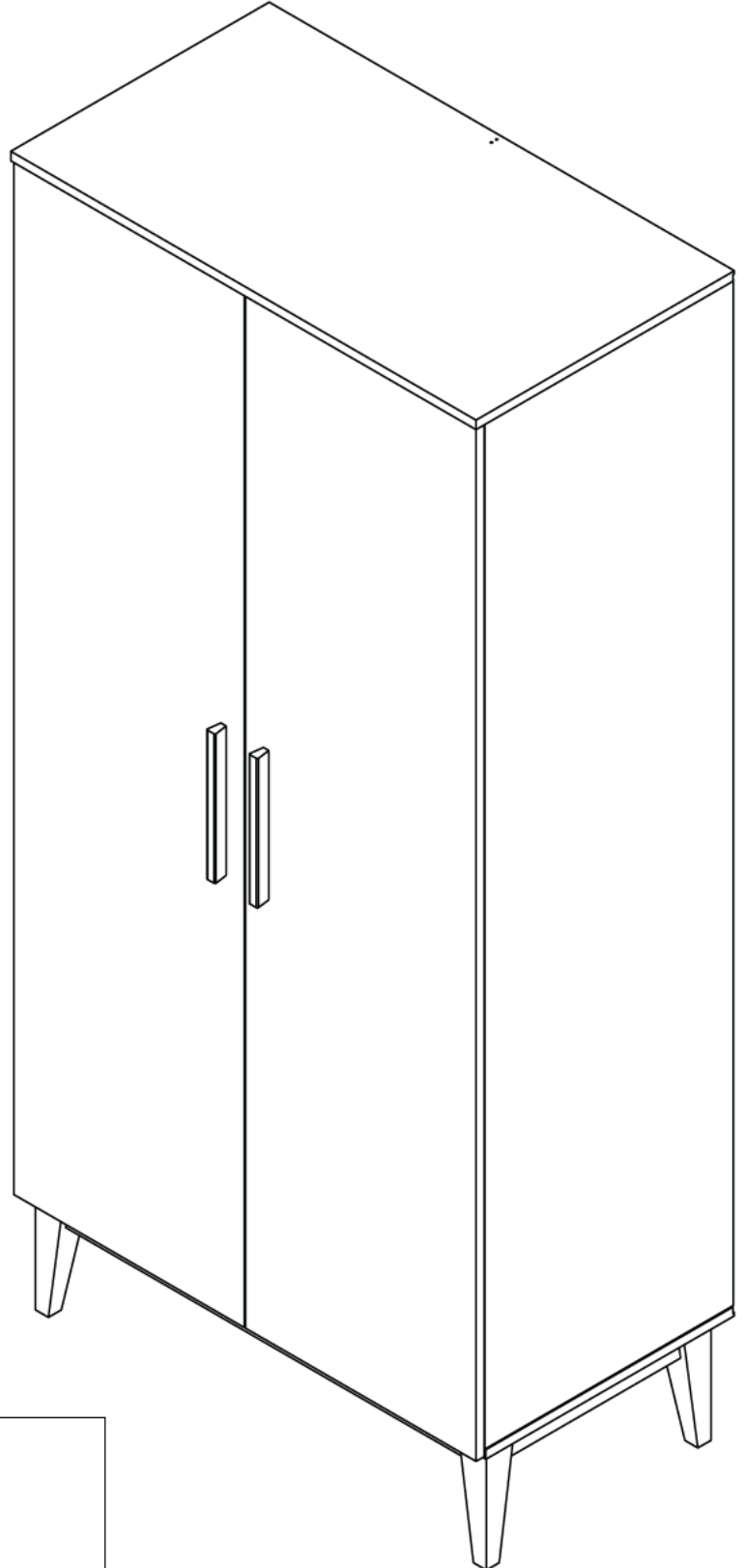
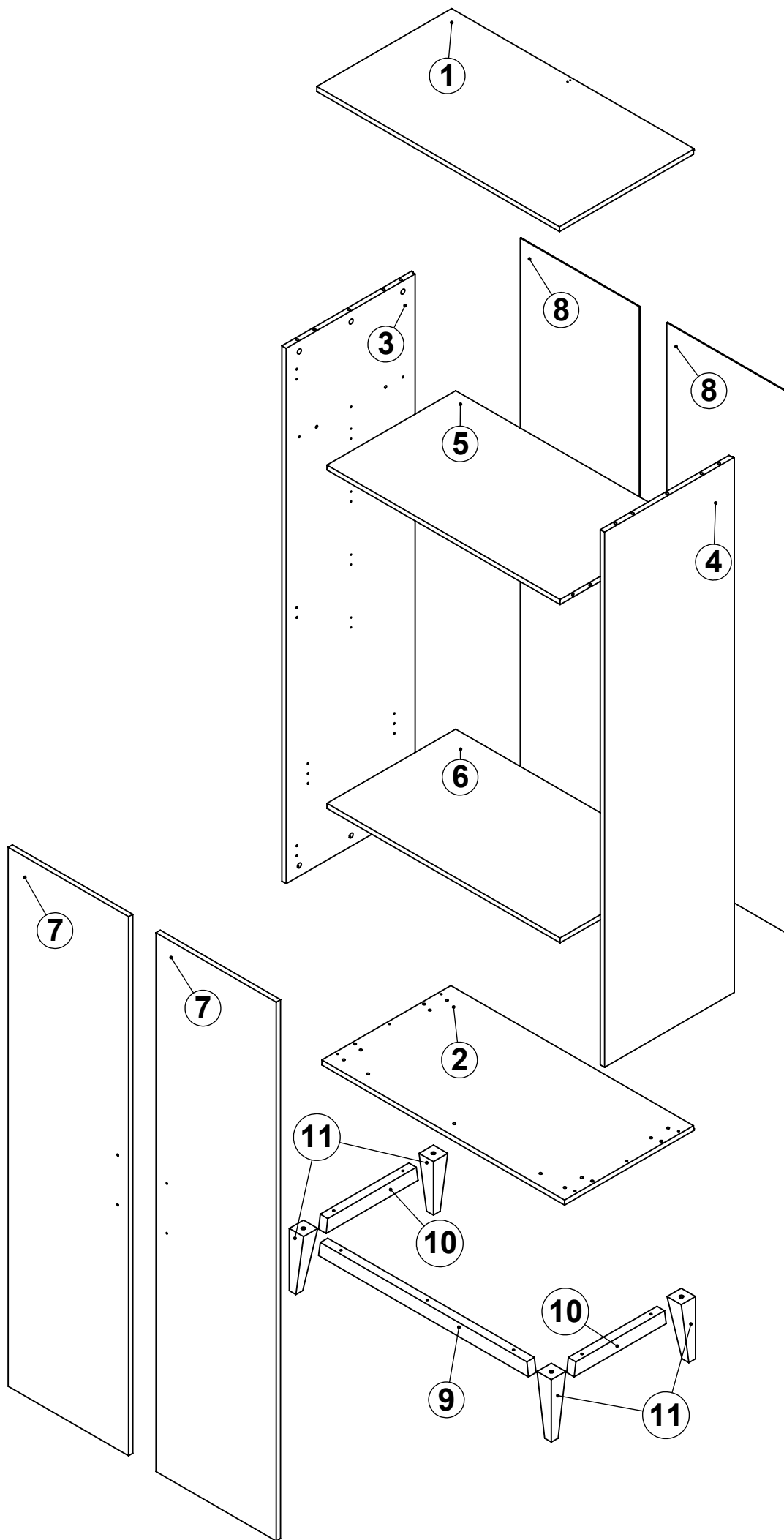

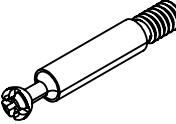
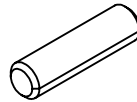
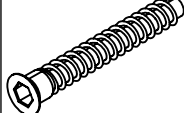
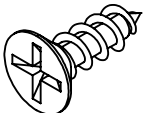
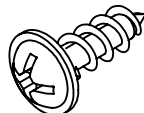
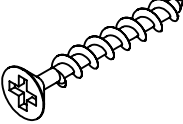
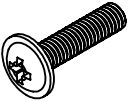
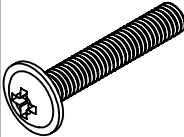
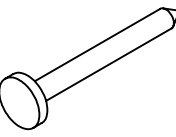
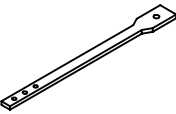
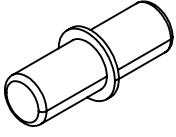
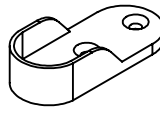
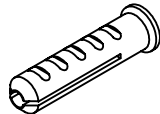
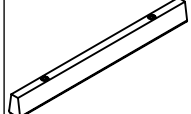
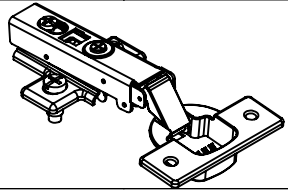
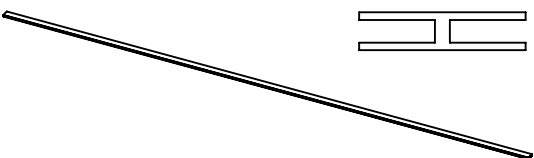
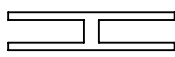
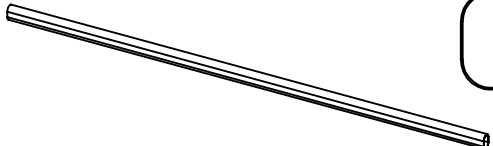

							
A x 18	B x 18	C x 12	D x 7	E x 16	F x 2	G x 1	H x 4
							
I x 4	J x 32	K x 1	L x 4	M x 2	N x 1	O x 2	
							
P1/P2 x 6/6	Q x 1				R x 1		





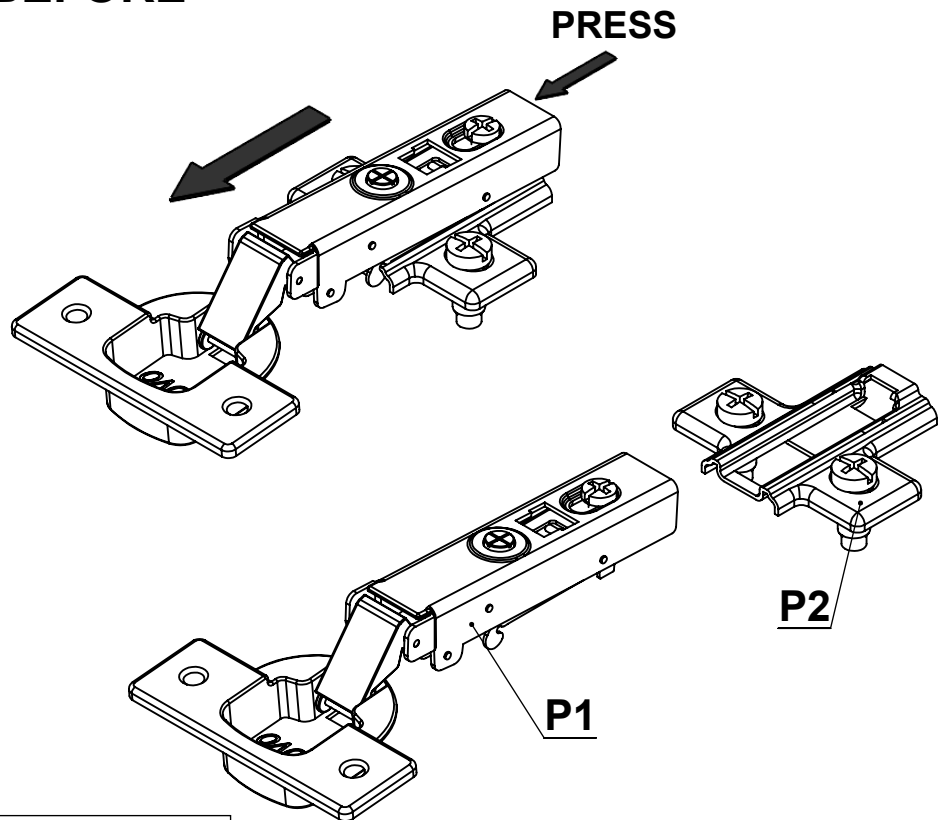

IMBUS

**UNSCREW BEFORE
ASSEMBLY**

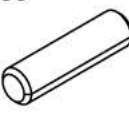

STEP - 1

			
Ax18	Bx6	Cx12	Ex4

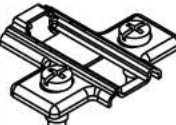
	
Mx2	P2x6

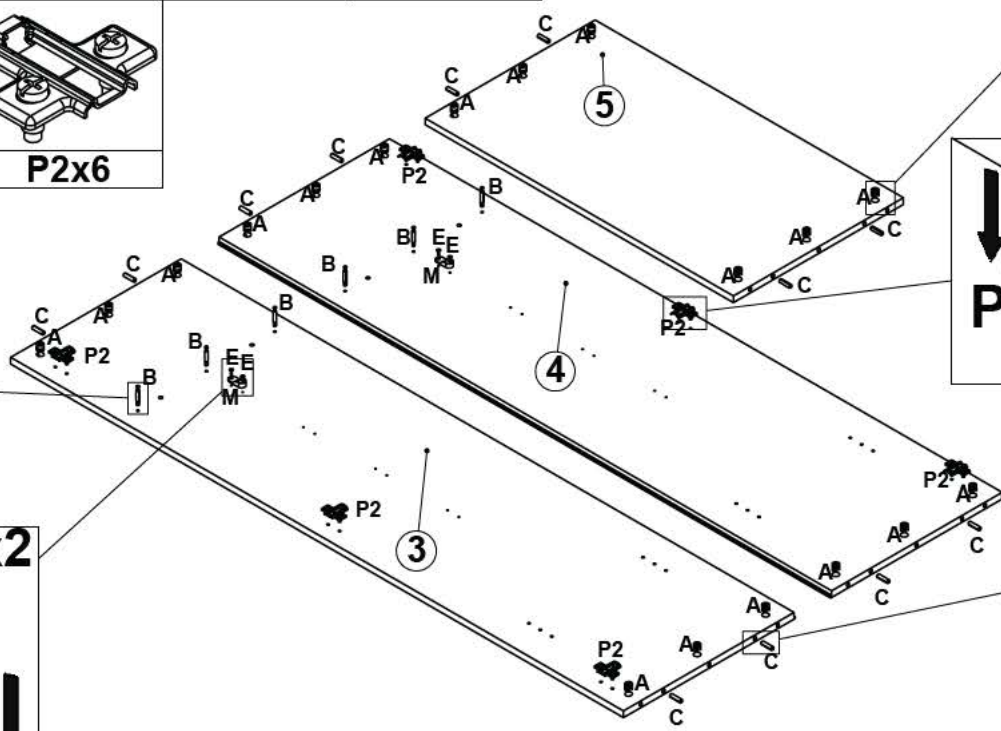
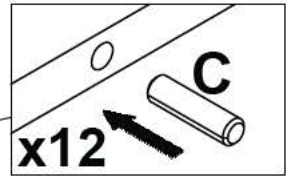
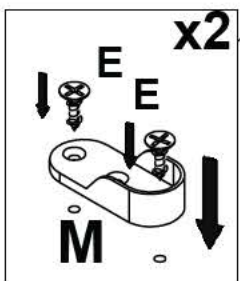
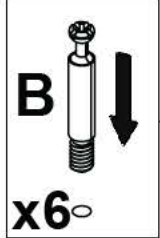
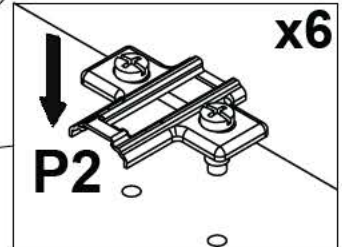
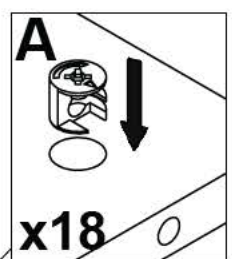

STEP - 2

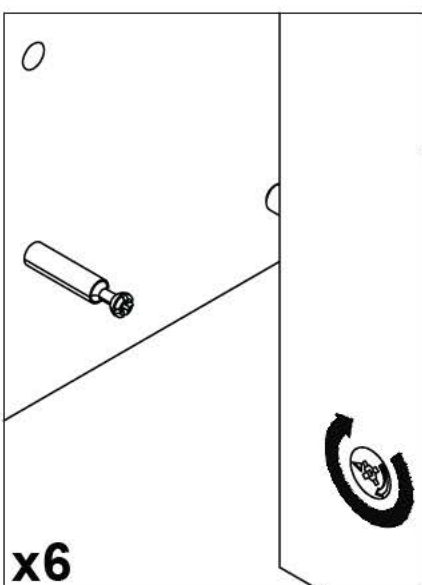
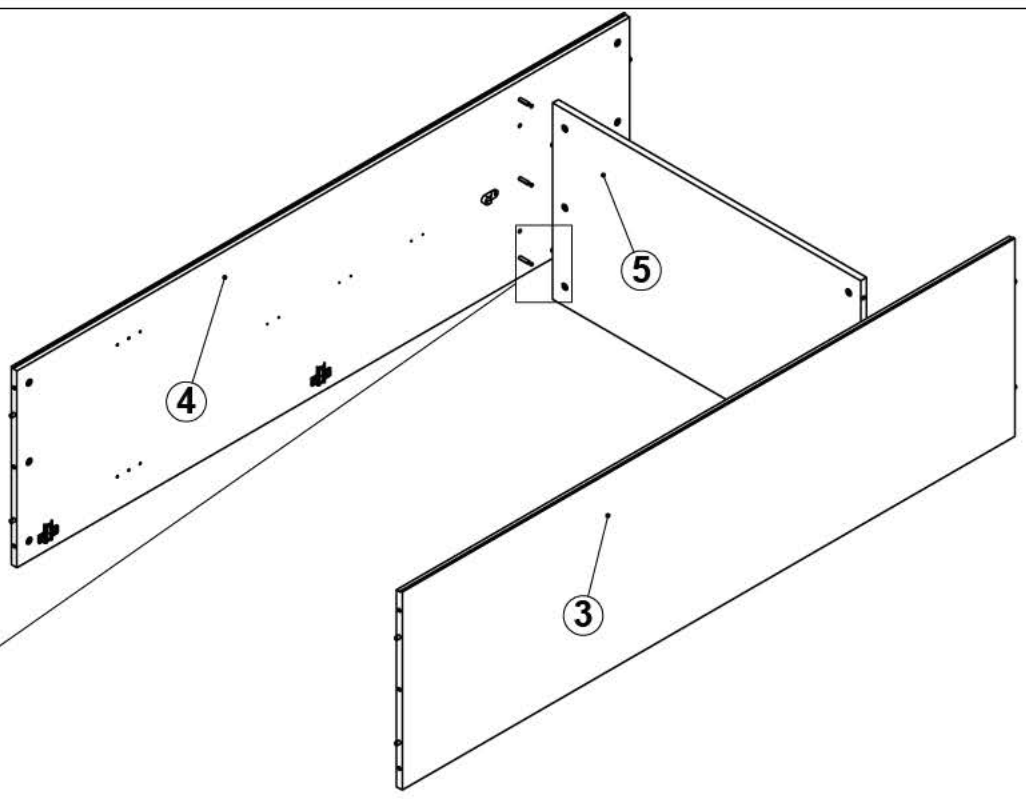

STEP - 3

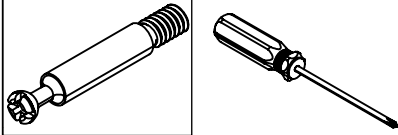

Bx12

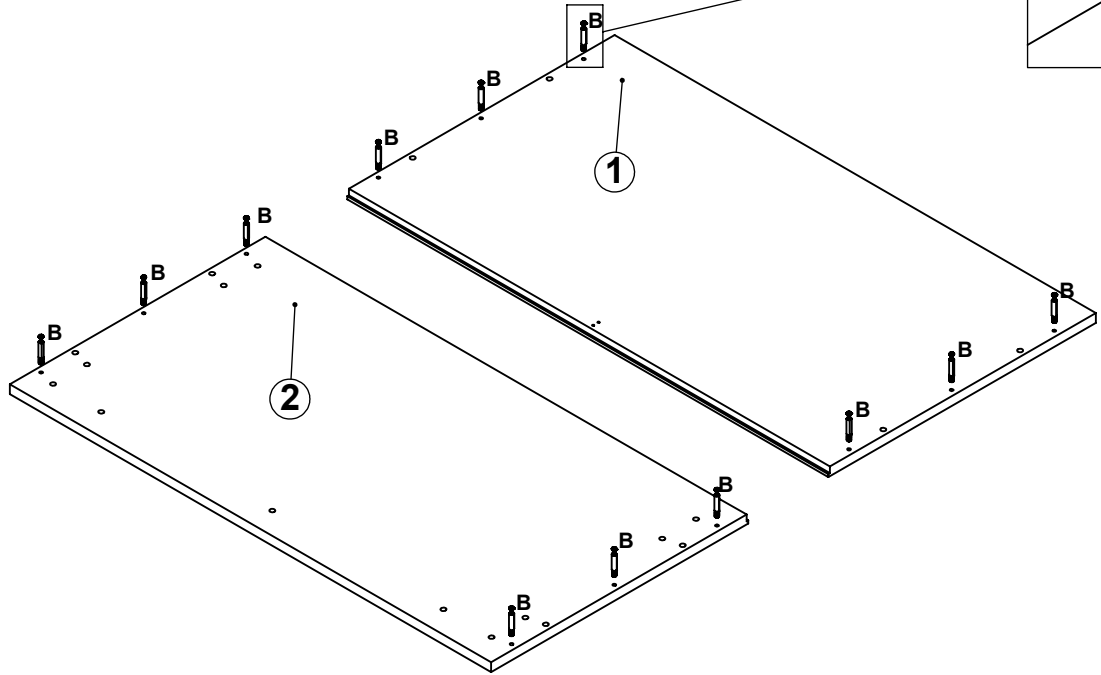
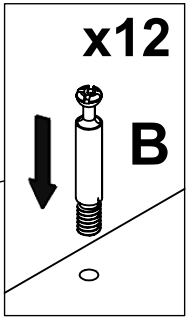

STEP - 4

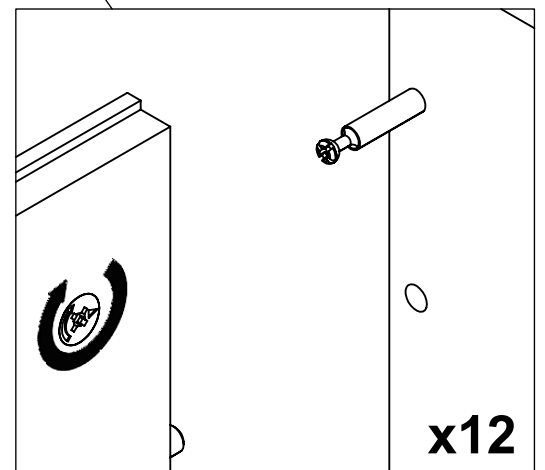
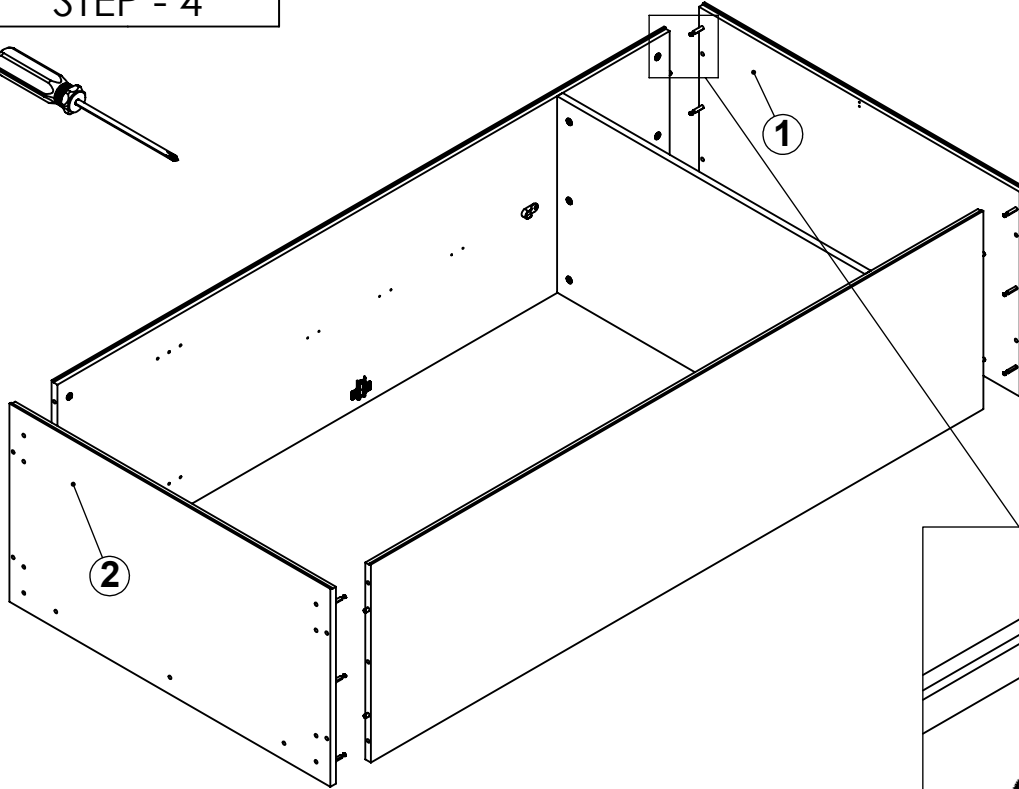
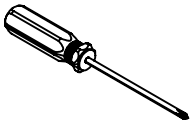

x12

STEP - 5

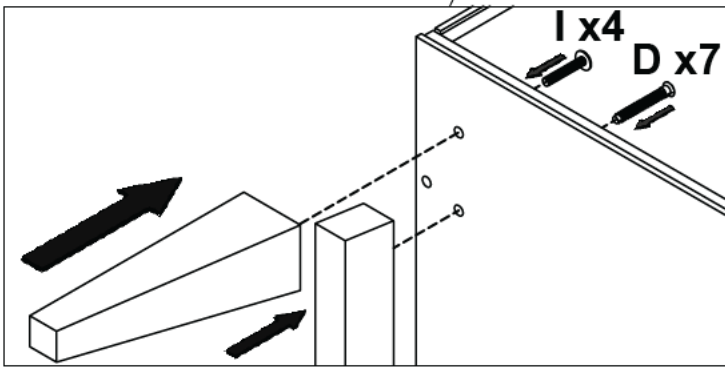
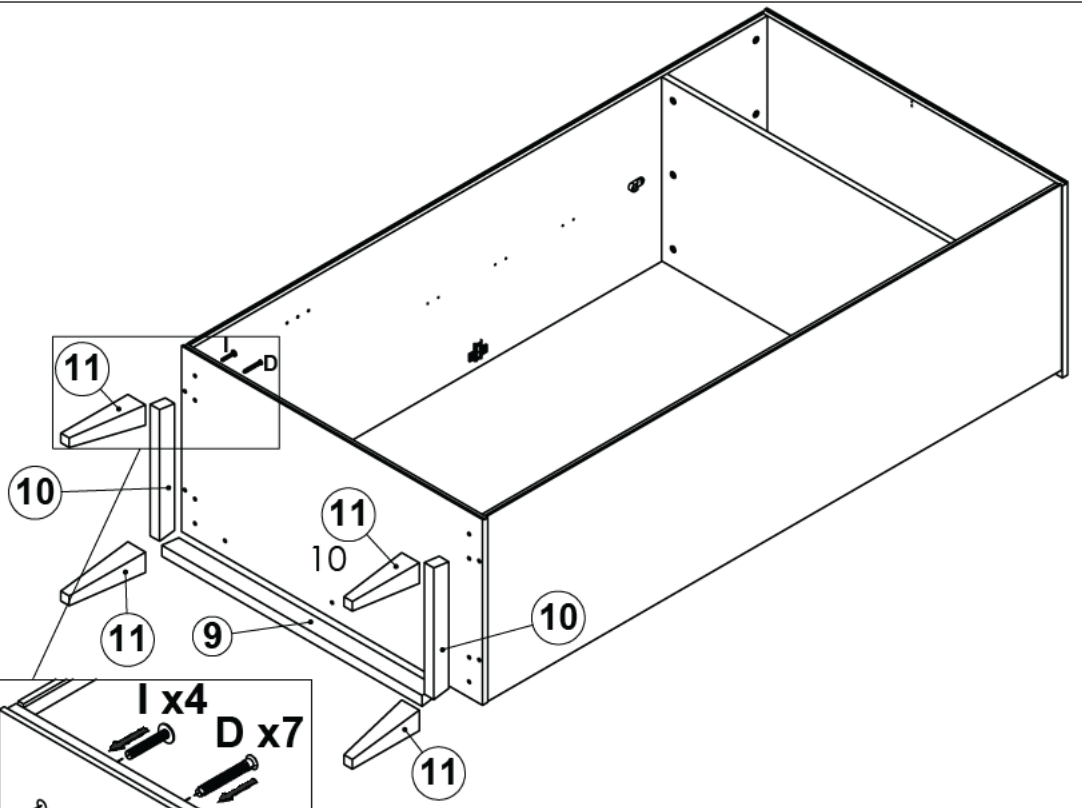
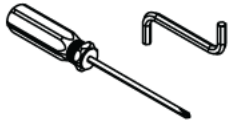
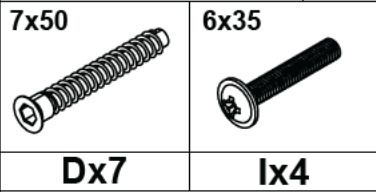

STEP - 6

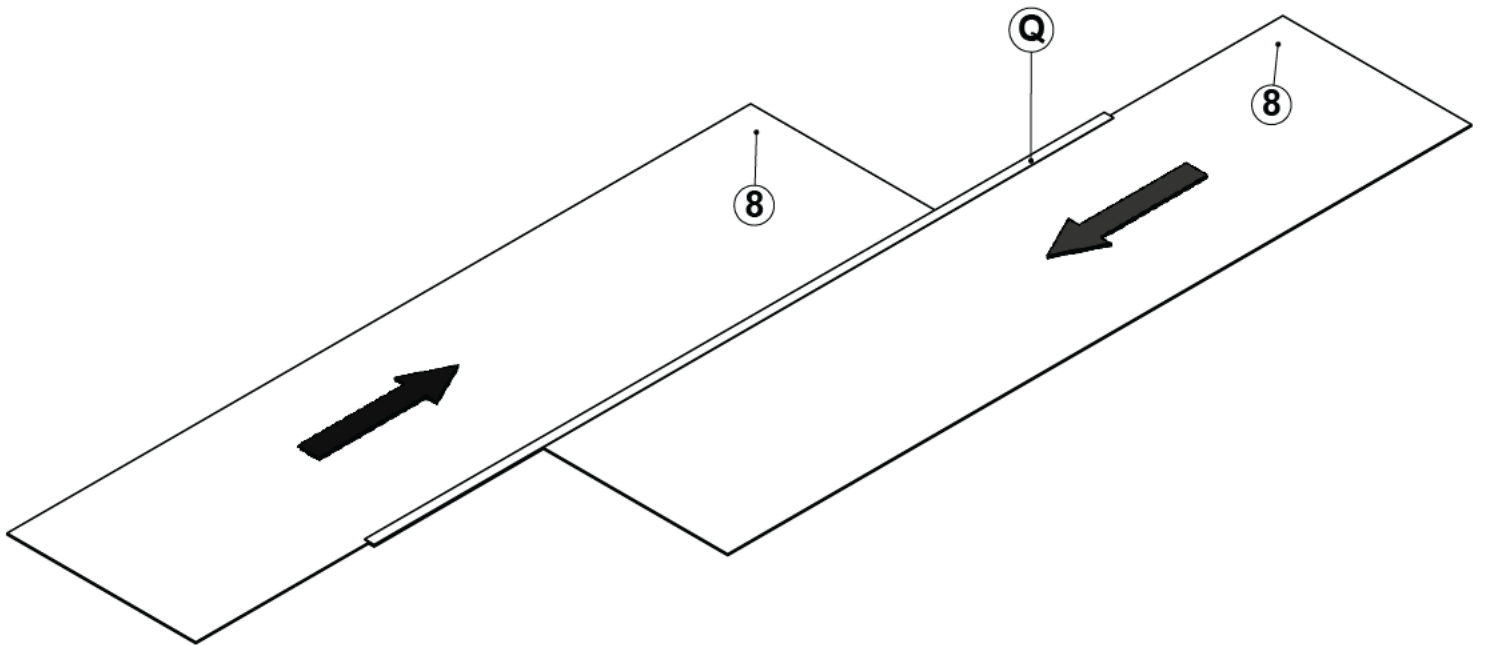
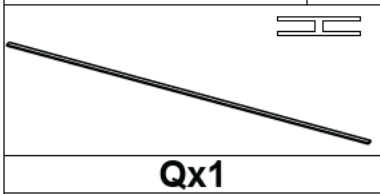

STEP - 7

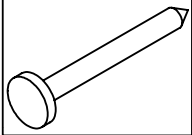

Jx32

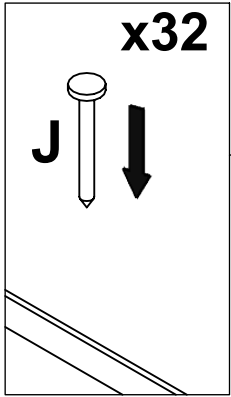
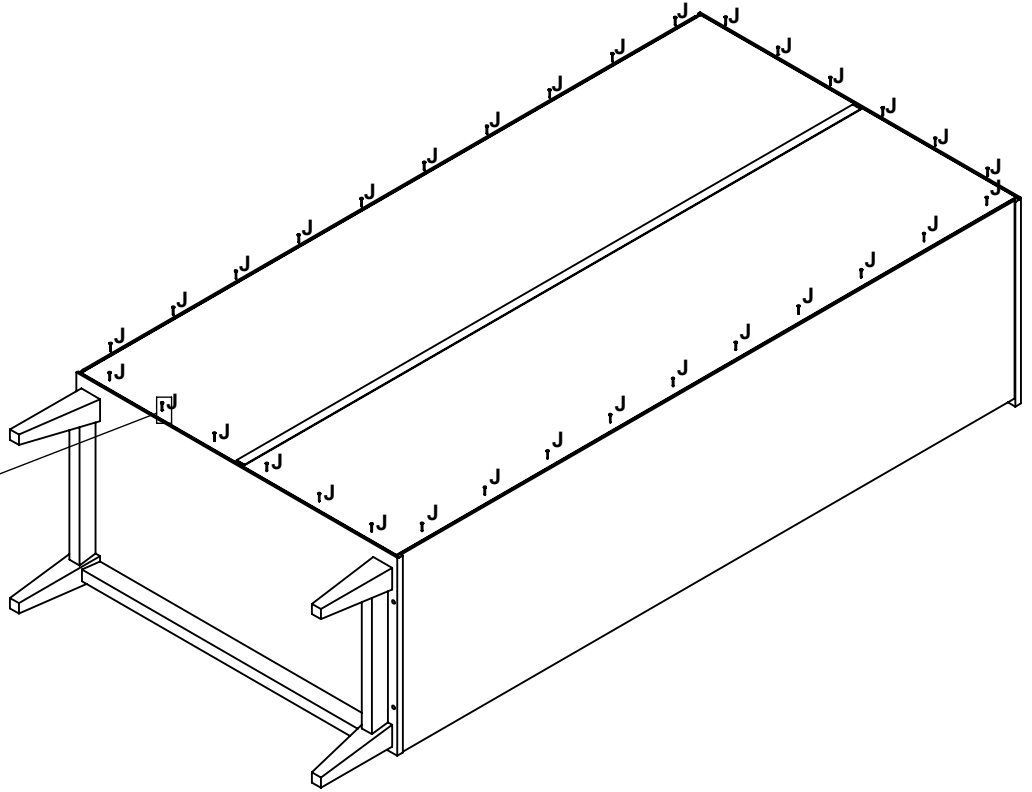
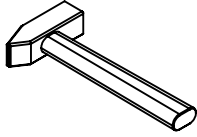

STEP - 8

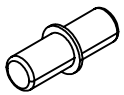

Lx4

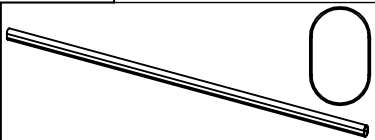

Rx1

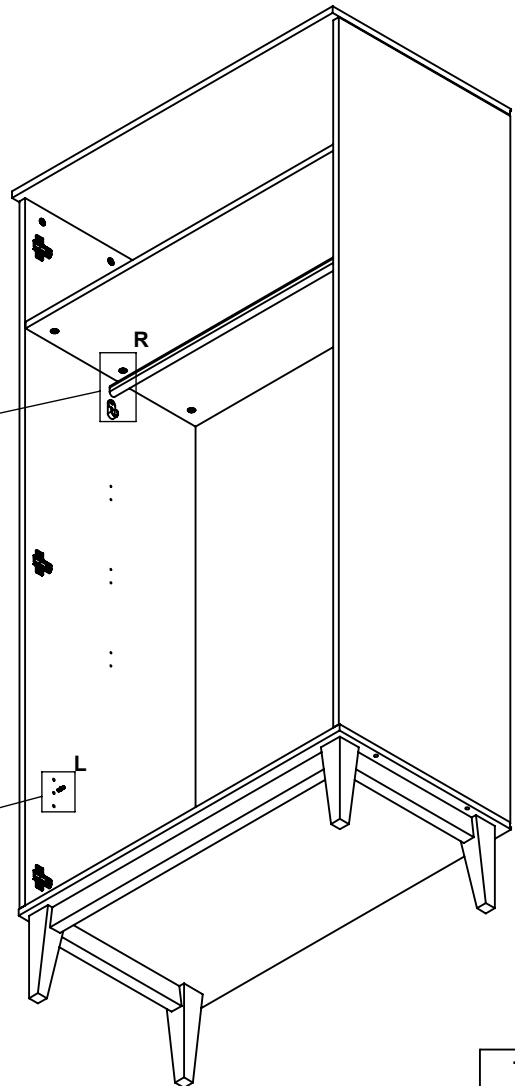
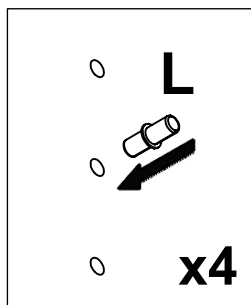
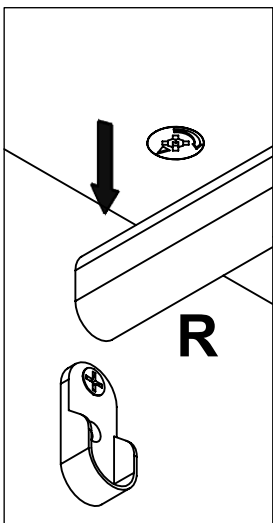

STEP - 9

3,5x13

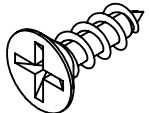

Ex12

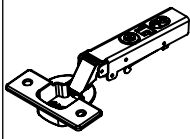

P1x6

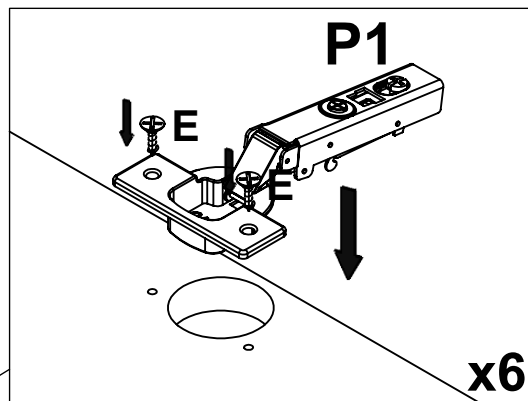
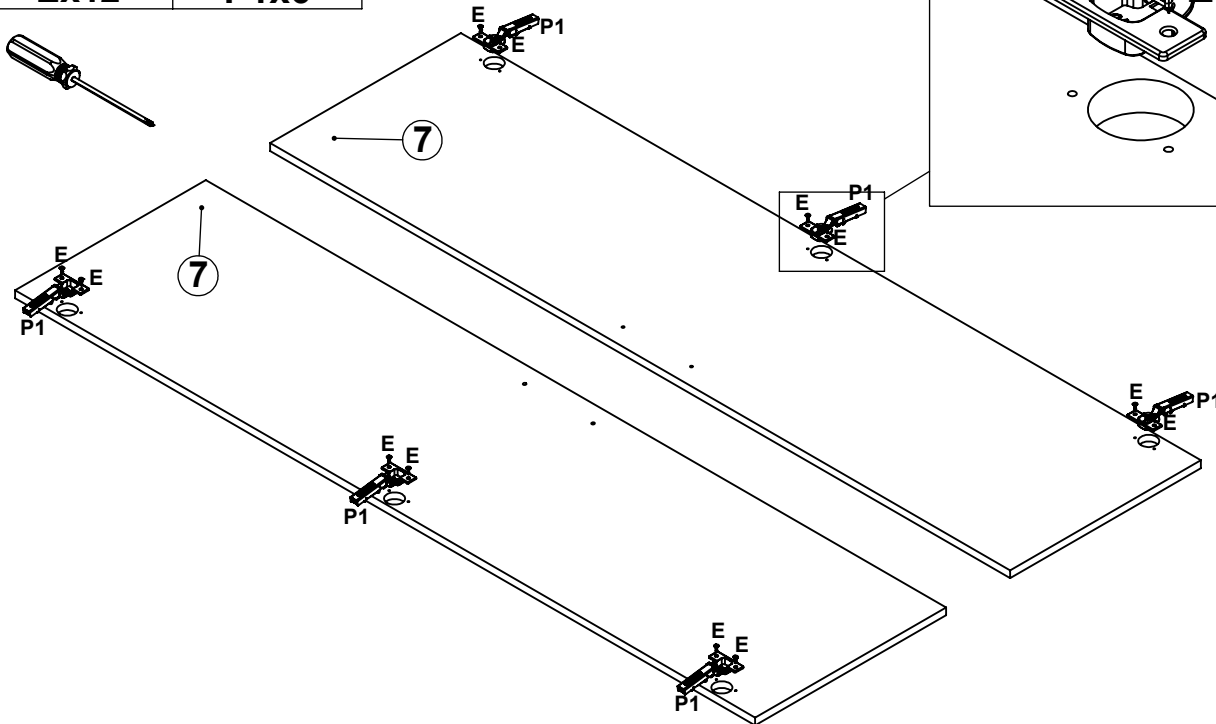
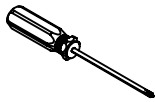

STEP - 10

4x25

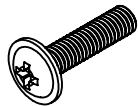

Hx4

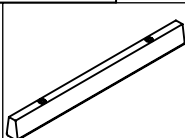

Ox2

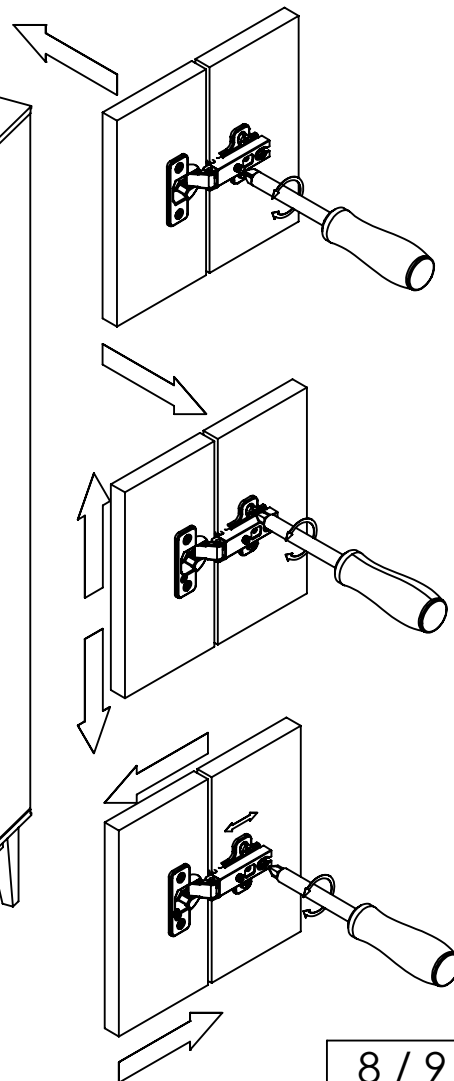
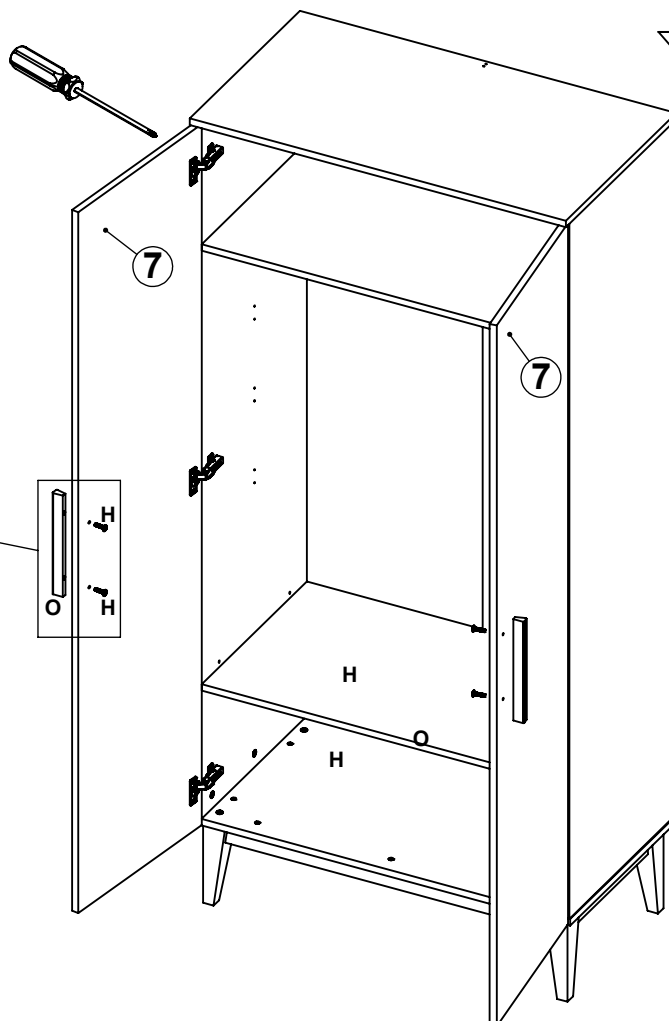
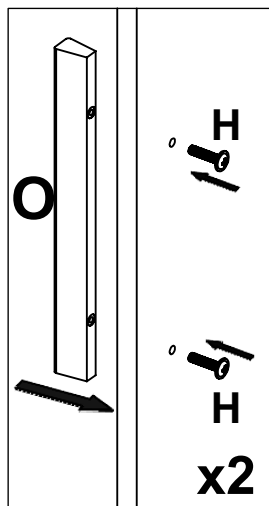
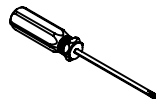

STEP - 11

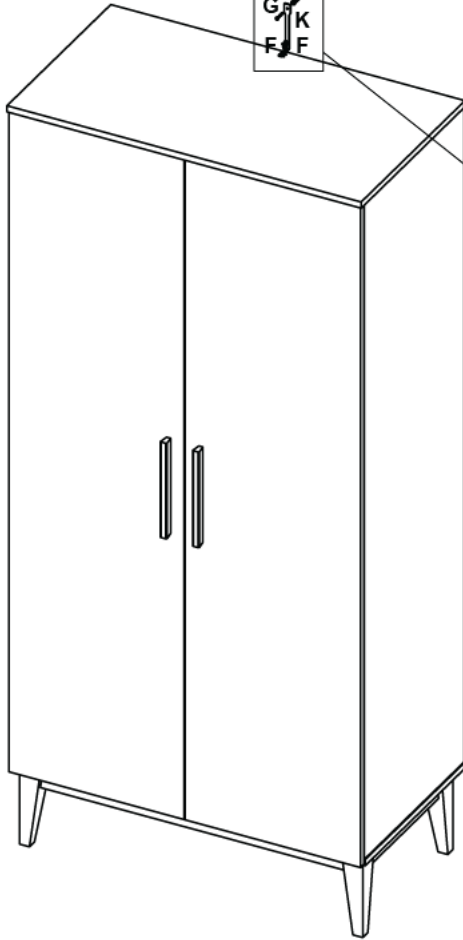
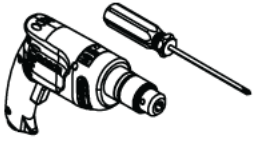

Fx2

5x45

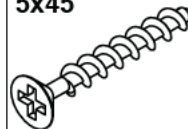

Gx1



Kx1



Nx1

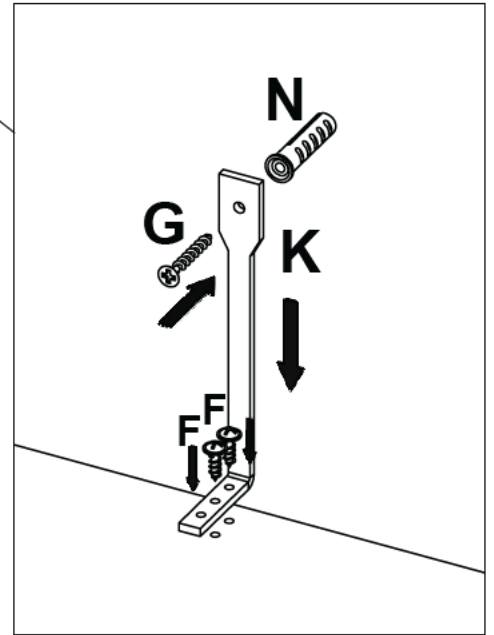

QC-CODE

(UK) for service requests

(NL) voor service vragen

(FR) pour les demandes de service

(DE) für Service Anfragen

(ES) para consultas de servicio

(IT) per richieste di assistenza

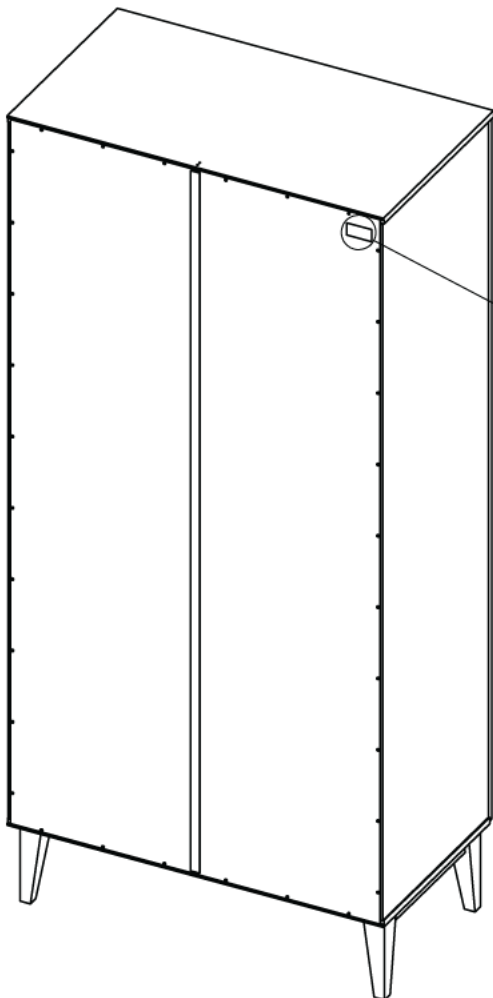

QC-CODE